

POTTERYBARN

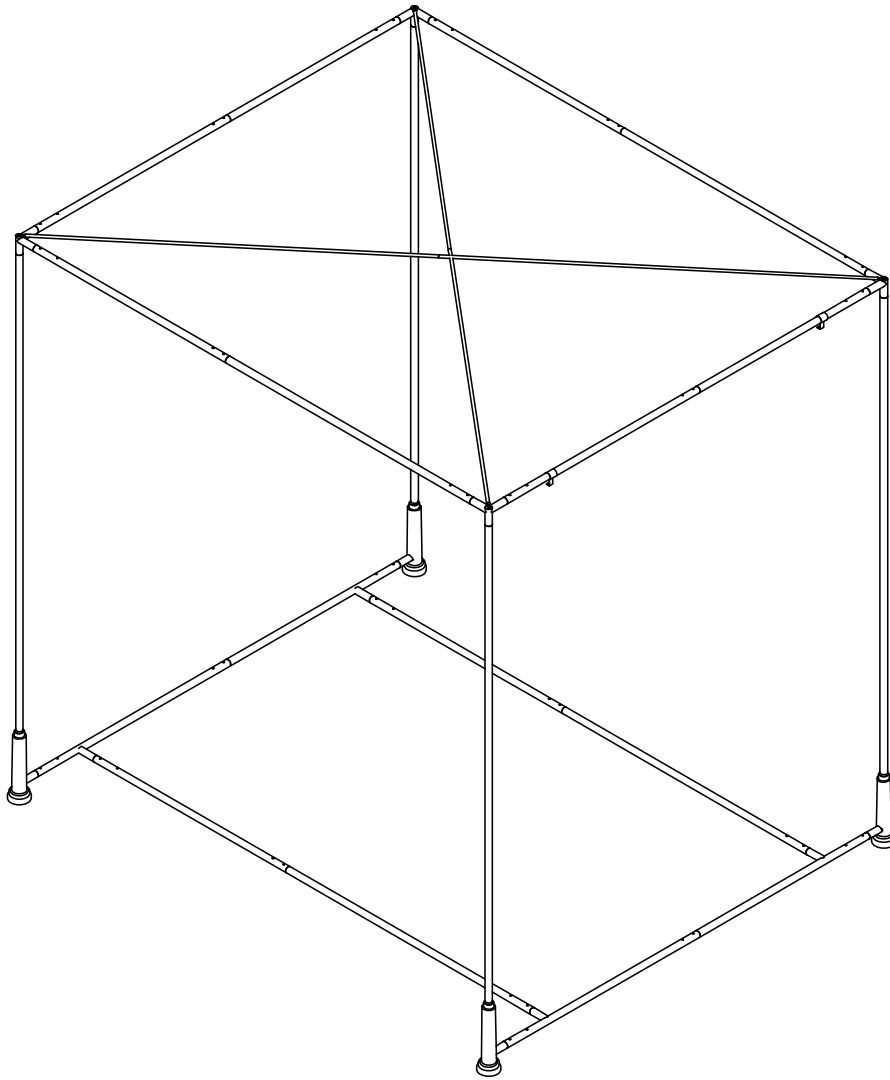

Canopy Bed Frame







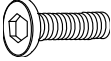

Important Safety Instructions:

- **WARNING:** Do not allow children to climb on, pull on, or hang from canopy. Failure to follow these instructions can result in serious bodily injury.
- Please read all instructions carefully before assembling.
- For your safety, assembly by 4 or more adults is strongly recommended.
- Assemble the frame in the desired place.
- Keep instructions for future use.
- Use only vendor supplied hardware to assemble. Using unauthorized hardware could jeopardize the structural integrity of the item.

Pre-assembly:

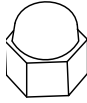
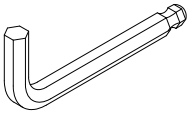
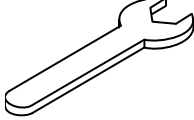
- Remove all parts and hardware from the box and lay out on a clear carpeted or scratch-free work surface, as this will avoid damaging parts during assembly. The shipping box provides an ideal work surface.
- Do not dispose of any packaging or contents of the shipping carton until assembly is completed to avoid accidentally discarding small parts or hardware.
- Use the parts and hardware lists below to identify and separate each of the pieces included.
- The illustrations provided allow for easier assembly when used in conjunction with the assembly instructions.
- The use of power tools to aid in assembly is not recommended. Power tools can damage hardware and split wood.

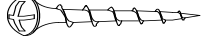
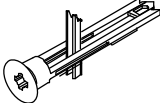
Hardware Included:

<p>(a) Bolt</p>  <p>M6 x 16mm 50x</p>	<p>(b) Round Head Bolt</p>  <p>M4 x 6mm 4x</p>	<p>(c) Long Bolt</p>  <p>M6 x 65mm 4x</p>
<p>(d) Flat Washer</p>  <p>4x</p>	<p>(e) Nut</p>  <p>2x</p>	<p>(f) 4mm Allen Wrench</p>  <p>1x</p>
<p>(g) Open Wrench</p>  <p>1x</p>	<p>(h) 2mm Allen Wrench</p>  <p>1x</p>	<p>(i) Mounting Screw</p>  <p>M4 x 50mm 2x</p>
<p>(j) Toggle</p>  <p>2x</p>		<p>(k) Toggle Screw</p>  <p>2x</p>

Parts Included:

Part	Description	QTY
(A)	Rail A	1x
(B)	Rail B	1x
(C)	Rail C	1x
(D)	Rail D	1x
(E)	Rail E	6x
(F)	Rail F	2x
(G)	Post	4x
(H)	Corner	4x
(I)	Mounting Bracket	2x
(J)	Rail J	4x
(K)	Rail K	2x
(L)	Rail L	2x
(M)	Rail M	2x
(N)	Rail N	2x

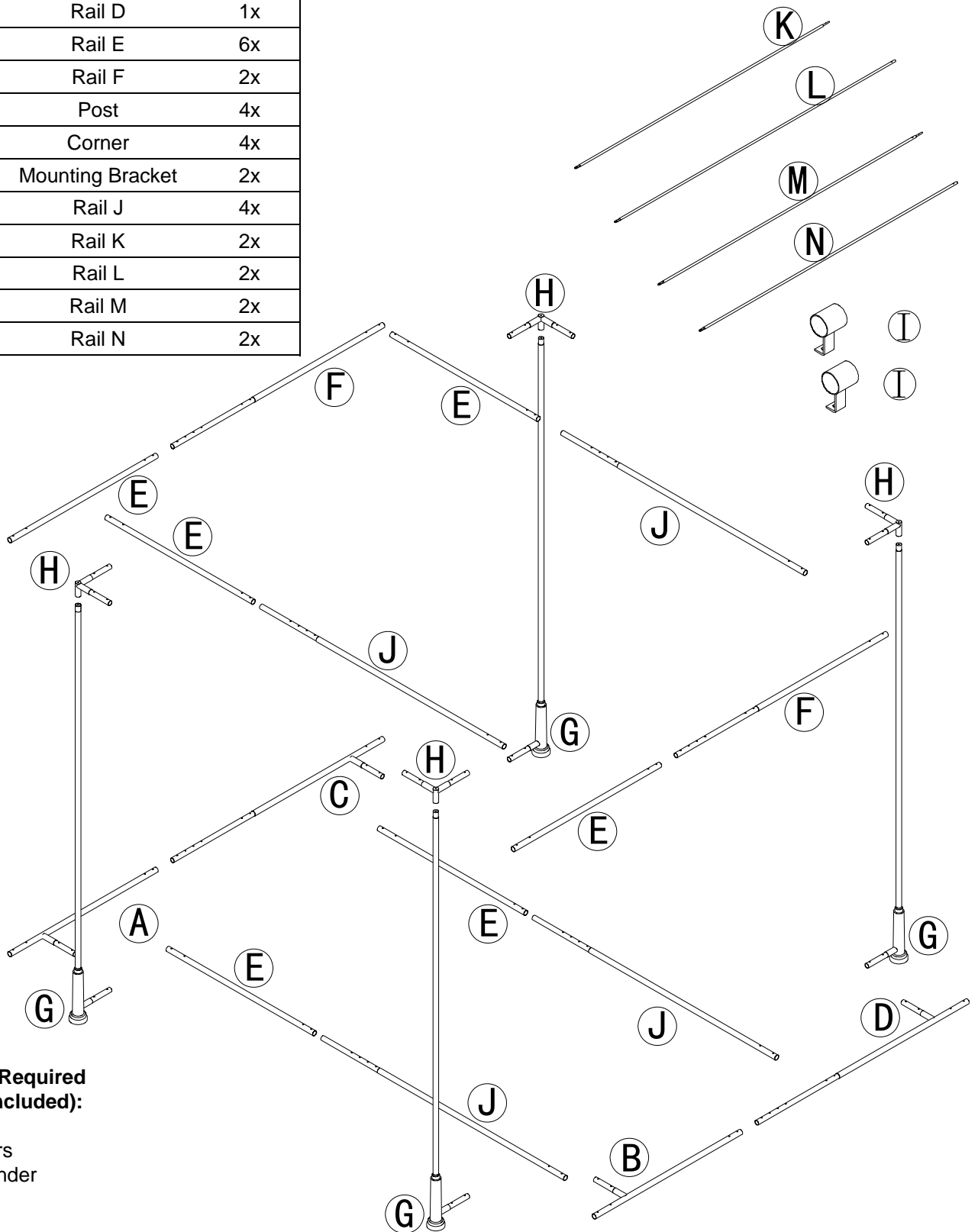

**Tools Required
(Not included):**

- Ladders
- Stud finder
- Pencil

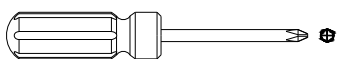

Phillips Head Screwdriver

Assembly Instruction Steps:

1. Attach Rail (A) to Rail (C) as shown, choose the correct holes for your bed size, insert Bolt (a) and tighten with 4mm Allen Wrench (f). Repeat this step for Rail (B&D) and 2 sets of Rail (E&F).

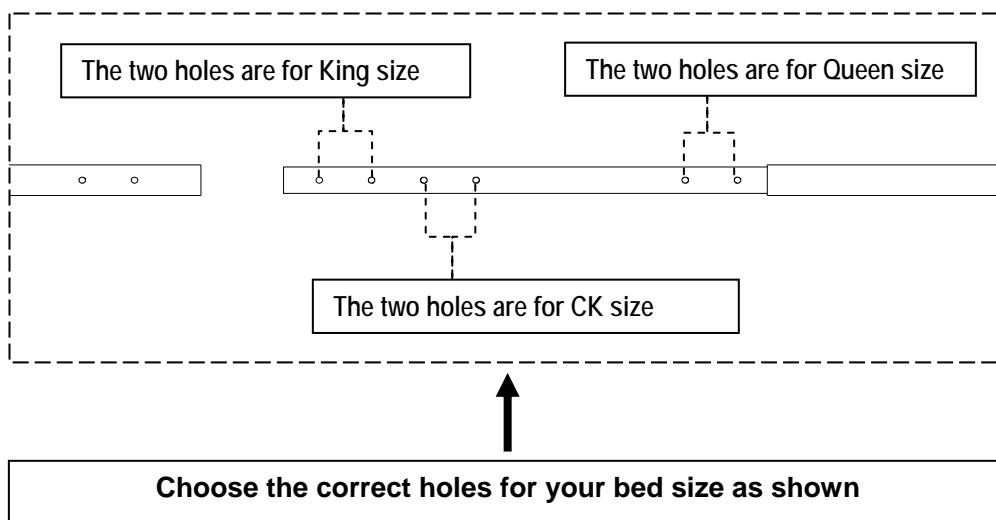
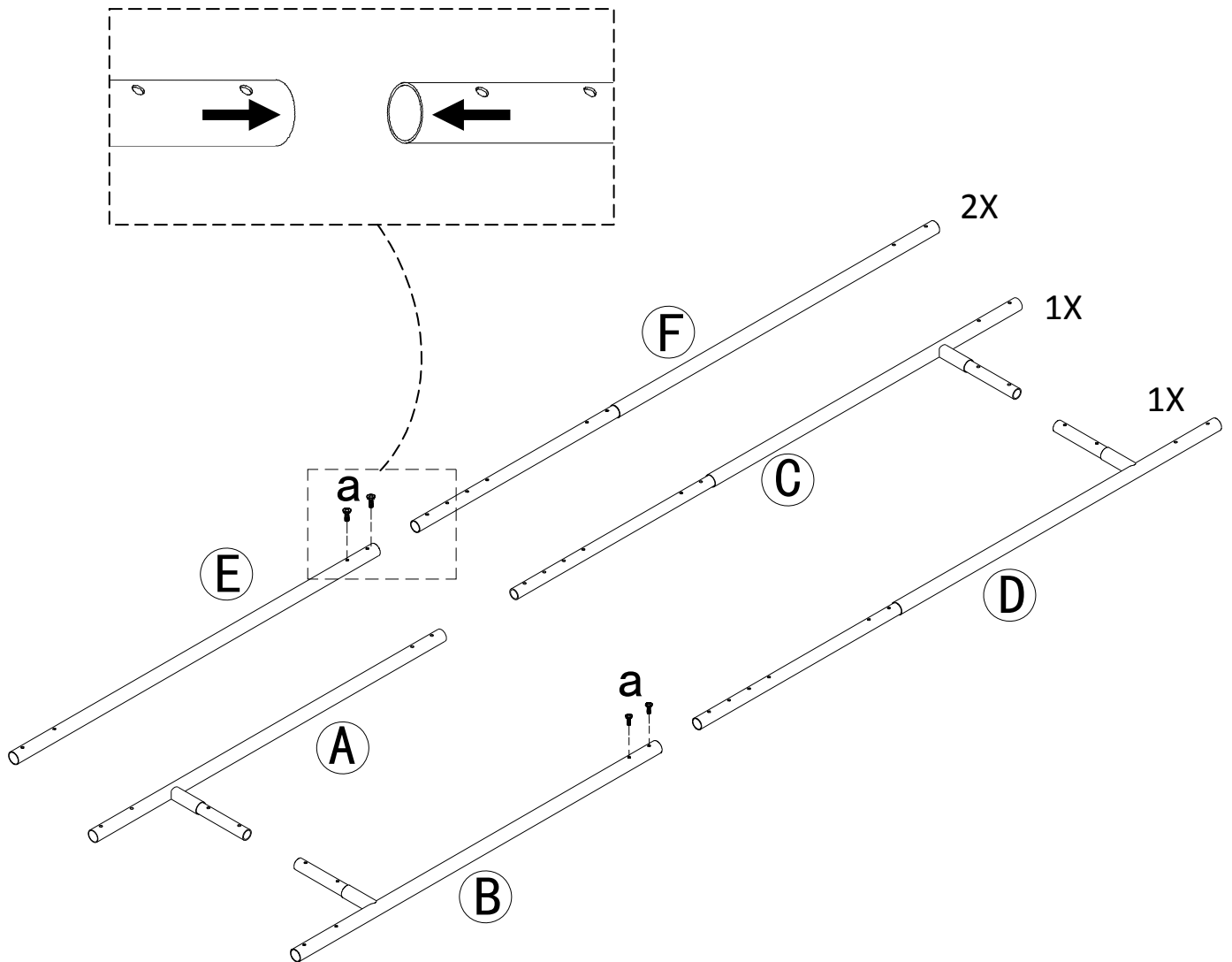

2. Attach Rail (E) to Rail (J) as shown, choose the correct holes for your bed size, insert Bolt (a) and tighten with 4mm Allen Wrench (f). Repeat this step to have 4 groups of Rail (E&J).

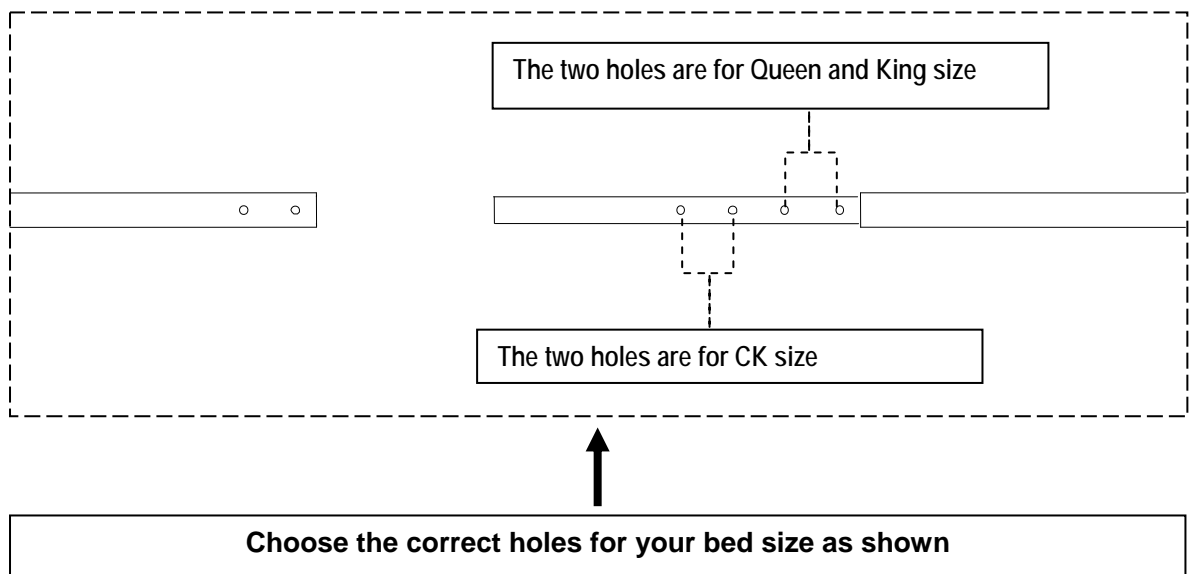
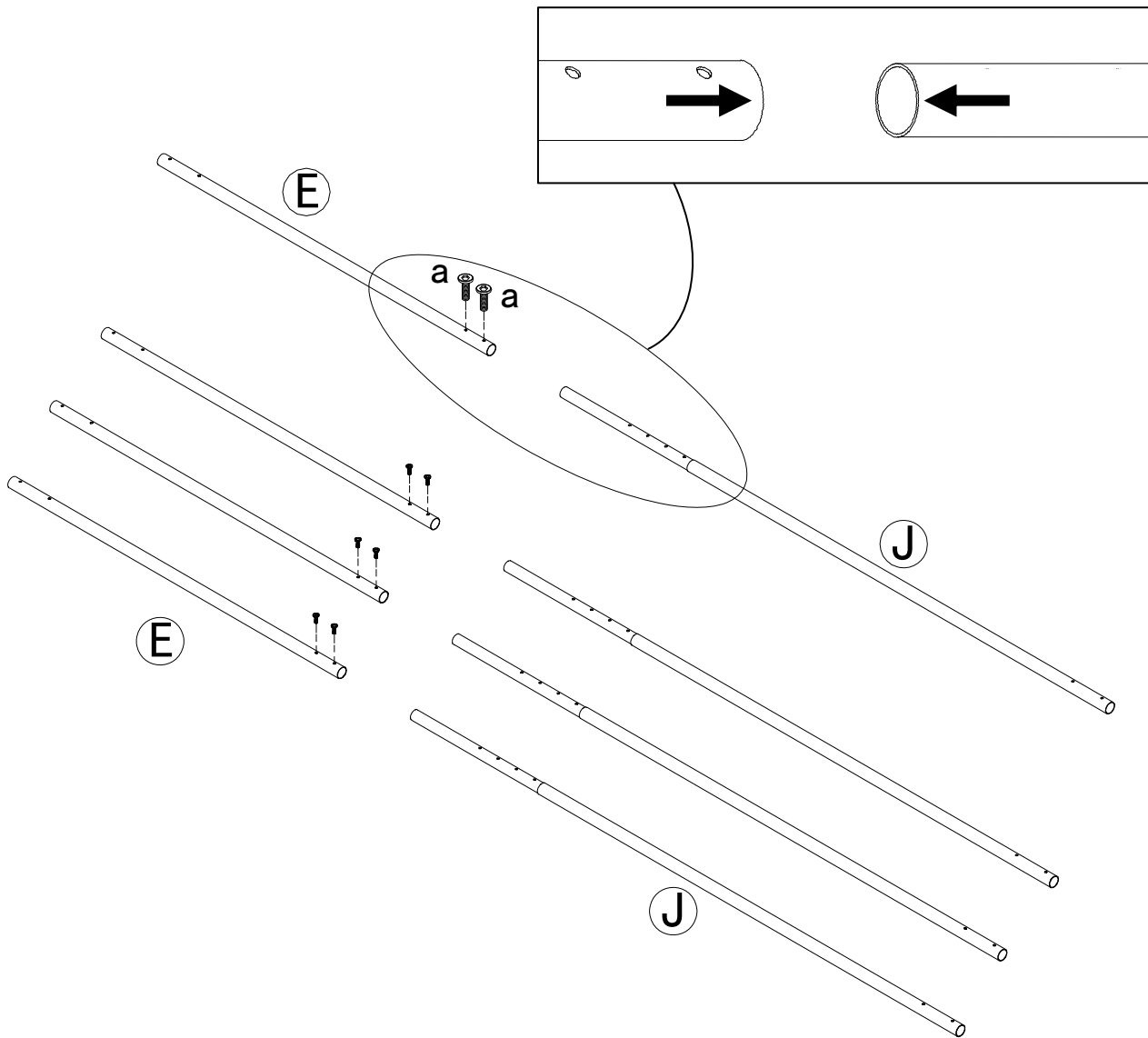

3. Attach the Assembly (A&C) and (B&D) to Assembly (E&J) as shown, insert Bolt (a) and tighten with 4mm Allen Wrench (f).

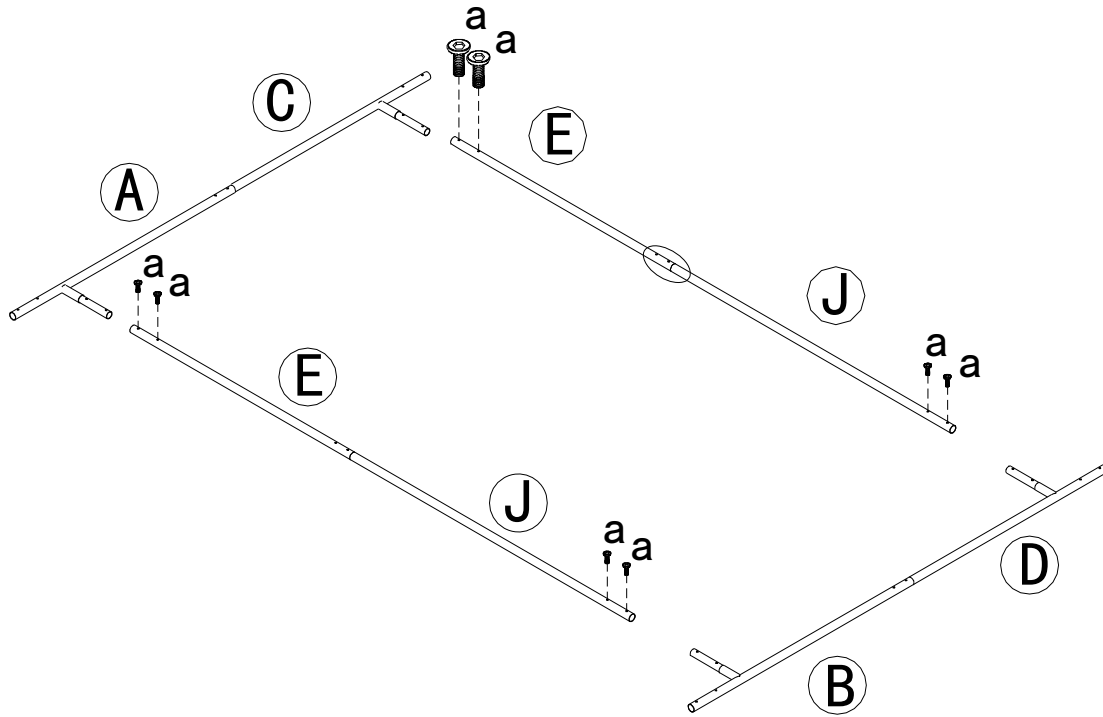

4. Attach Post (G) to the assembly in step 3 as shown, insert Bolt (a) and tighten with 4mm Allen Wrench (f).

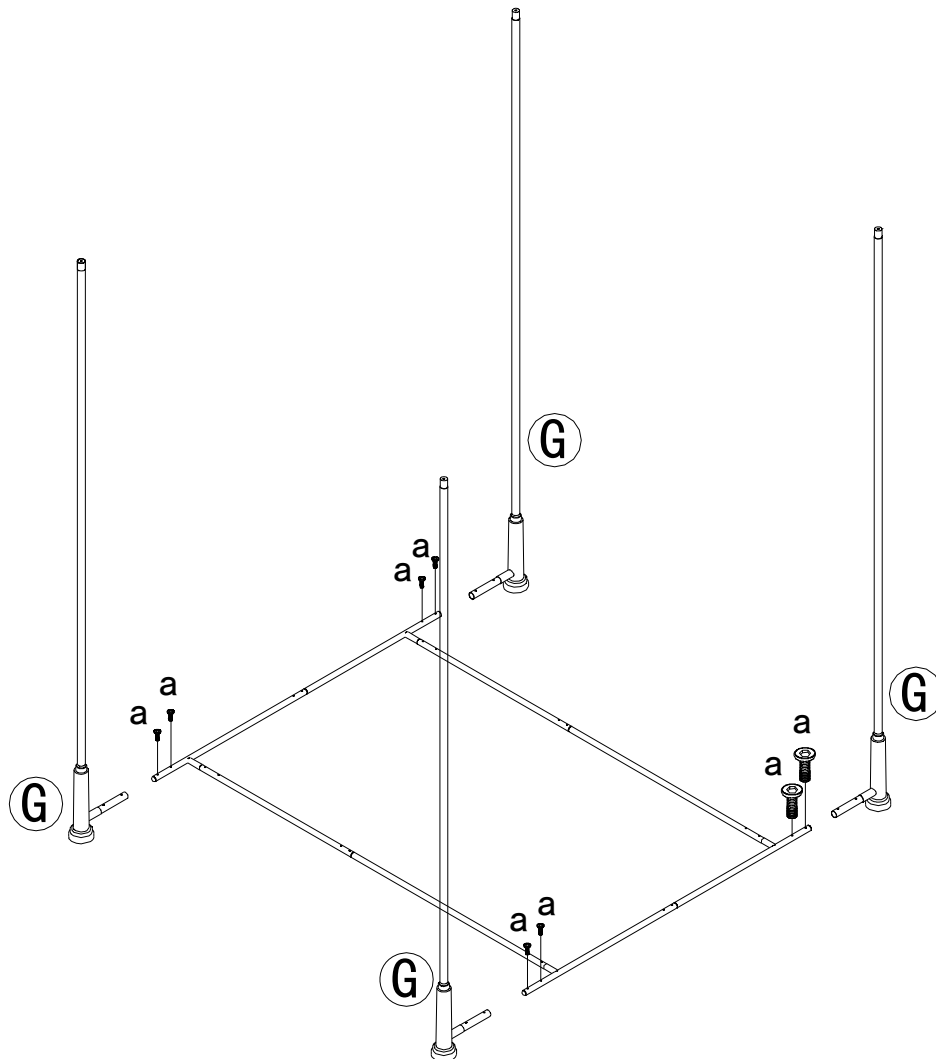

5. Insert Mounting Bracket (I) to Rail (E) and Rail (F) as shown. **NOTE:** Screw or unscrew the small bolt on the bracket with 2mm Allen Wrench (h) to tighten or loosen the bracket on the rail. Attach Corner (H) to the Group (E&F) and Group (E&J). Insert Bolt (a) and tighten with 4mm Allen Wrench (f).

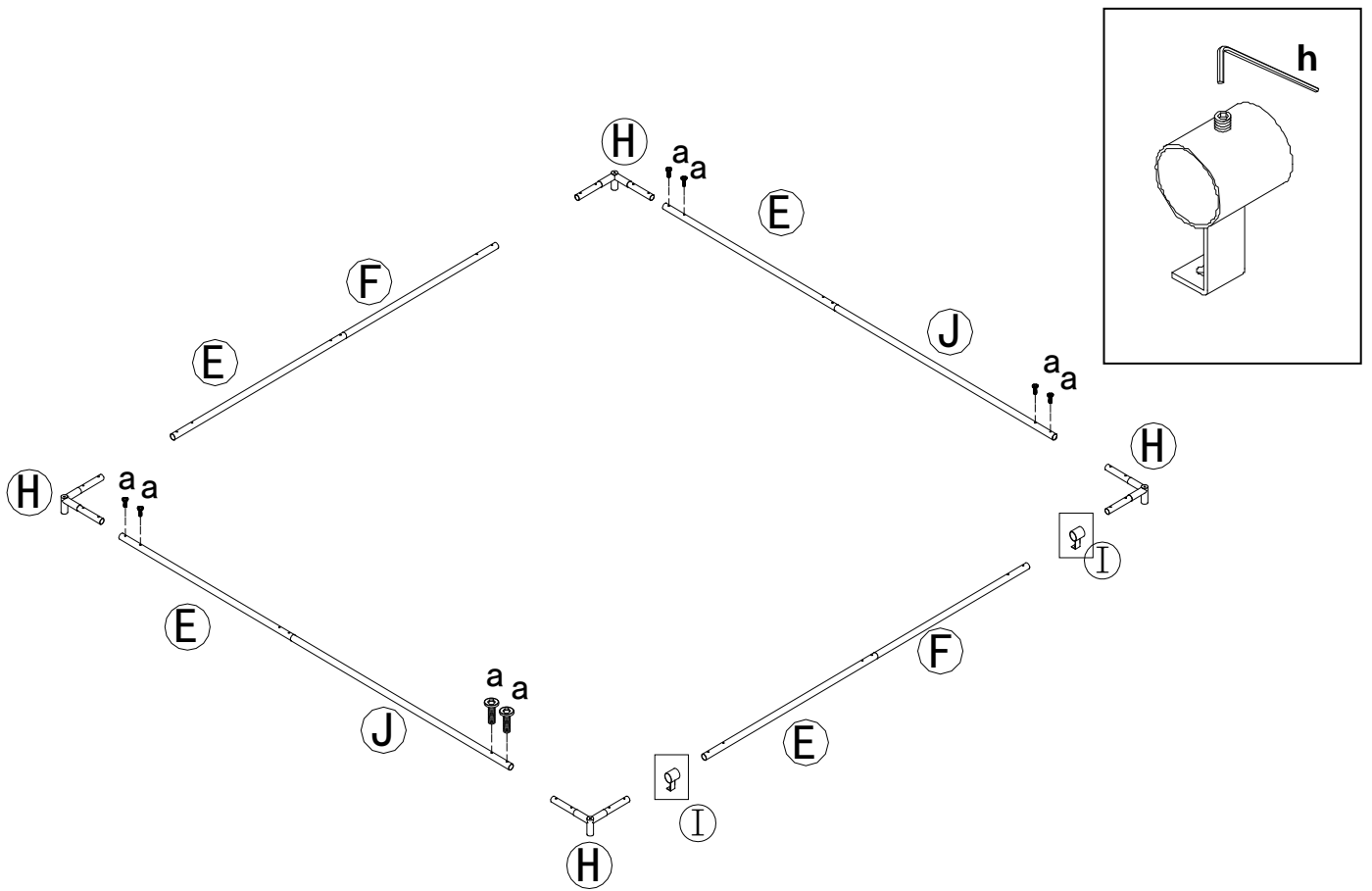

6. Carefully lift assembly in step 5 with 4 persons, and then attach it to the post as shown.

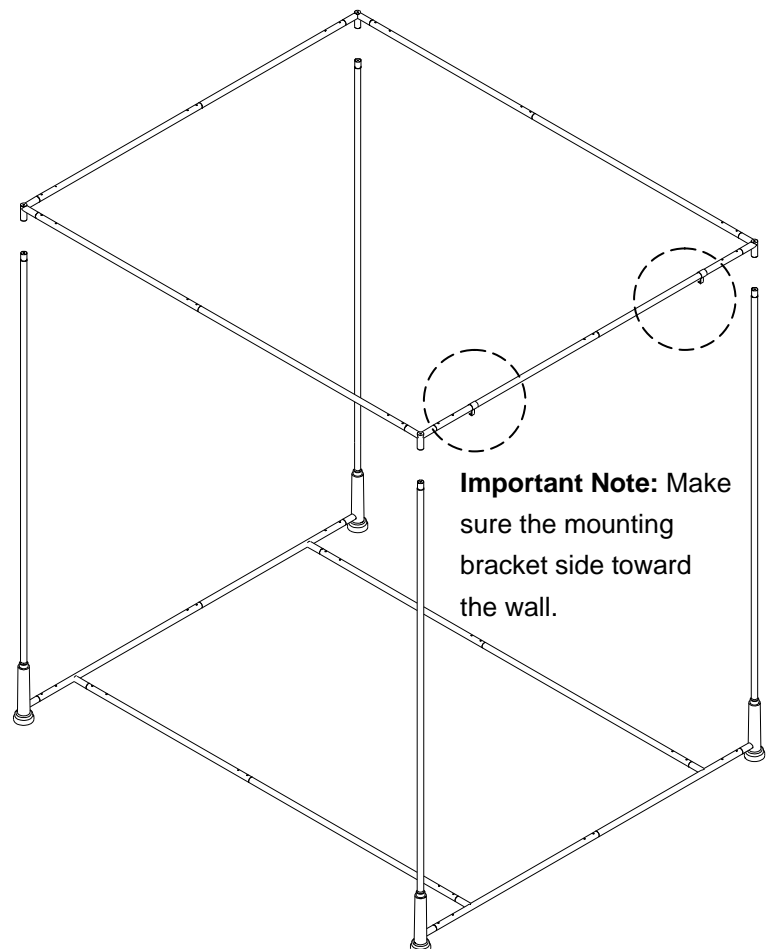

7. Rails (K&L) are for Queen Size, Rails (M&N) are for King & CK Size. Choose the correct rails for your bed.
(Illustration only shows Queen Size)

Attach Rail (K) to Rail (L) as shown, insert Round Head Bolt (b) and tighten with Phillips Head Screwdriver

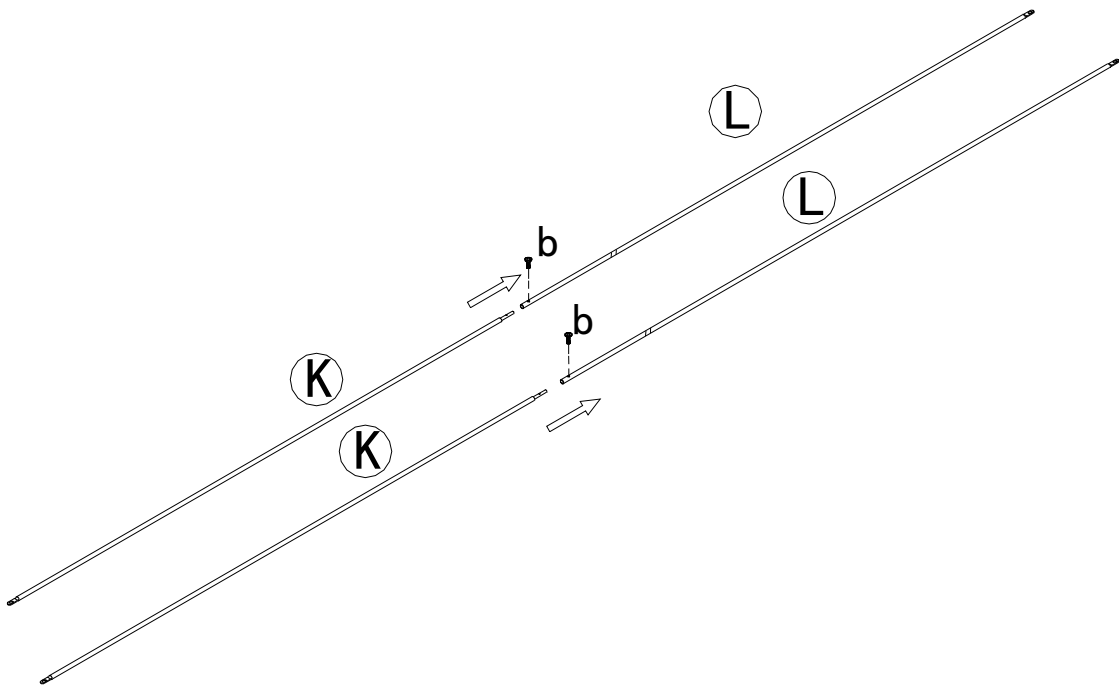

8. Secure the group (K&L) with Canopy Bolt (a), Nut (e) and tighten with 4mm Allen Wrench (f) and Open Wrench (g). **DO NOT** fully tighten the bolt in this step.

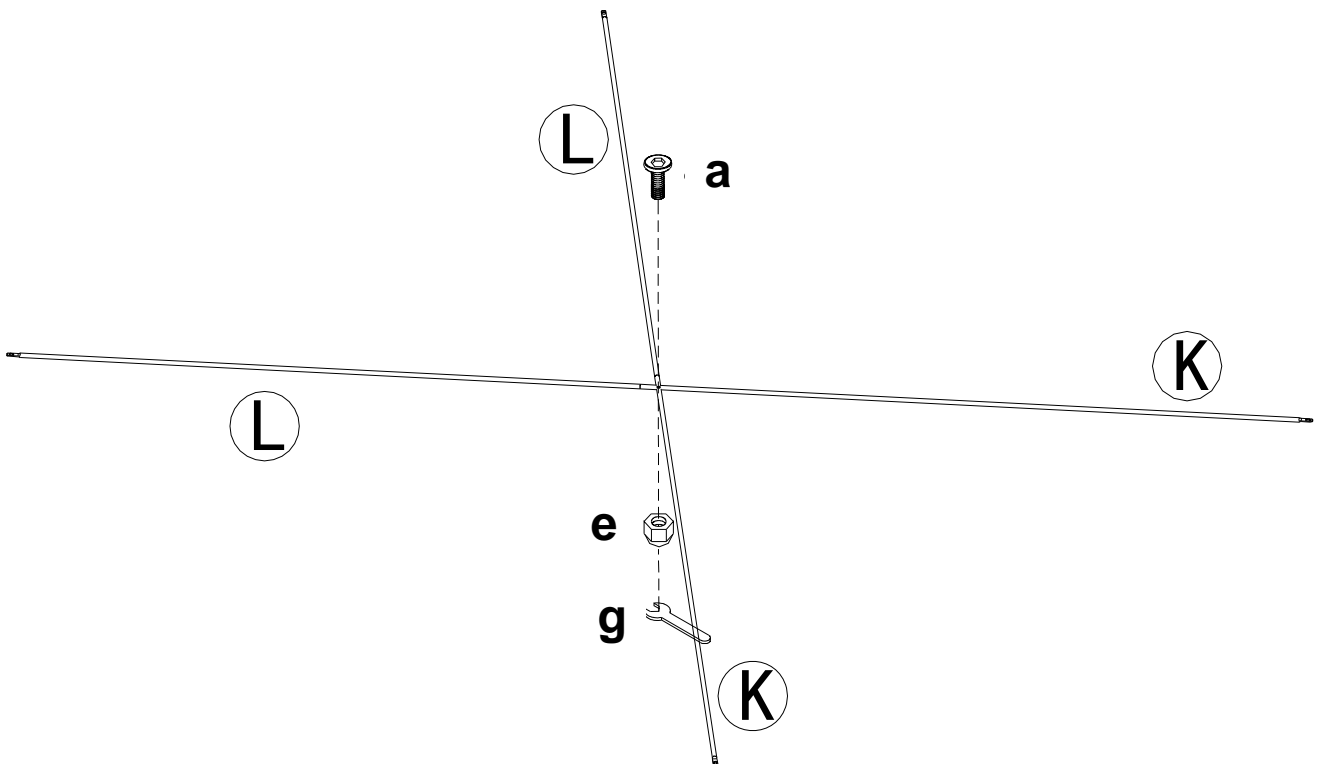

9. Attach the Canopy to the top corner with 4 persons as shown, insert Long Bolt (c) thru Flat Washer (d) and tighten with 4mm Allen Wrench (e). **Finally fully tighten all bolts.**

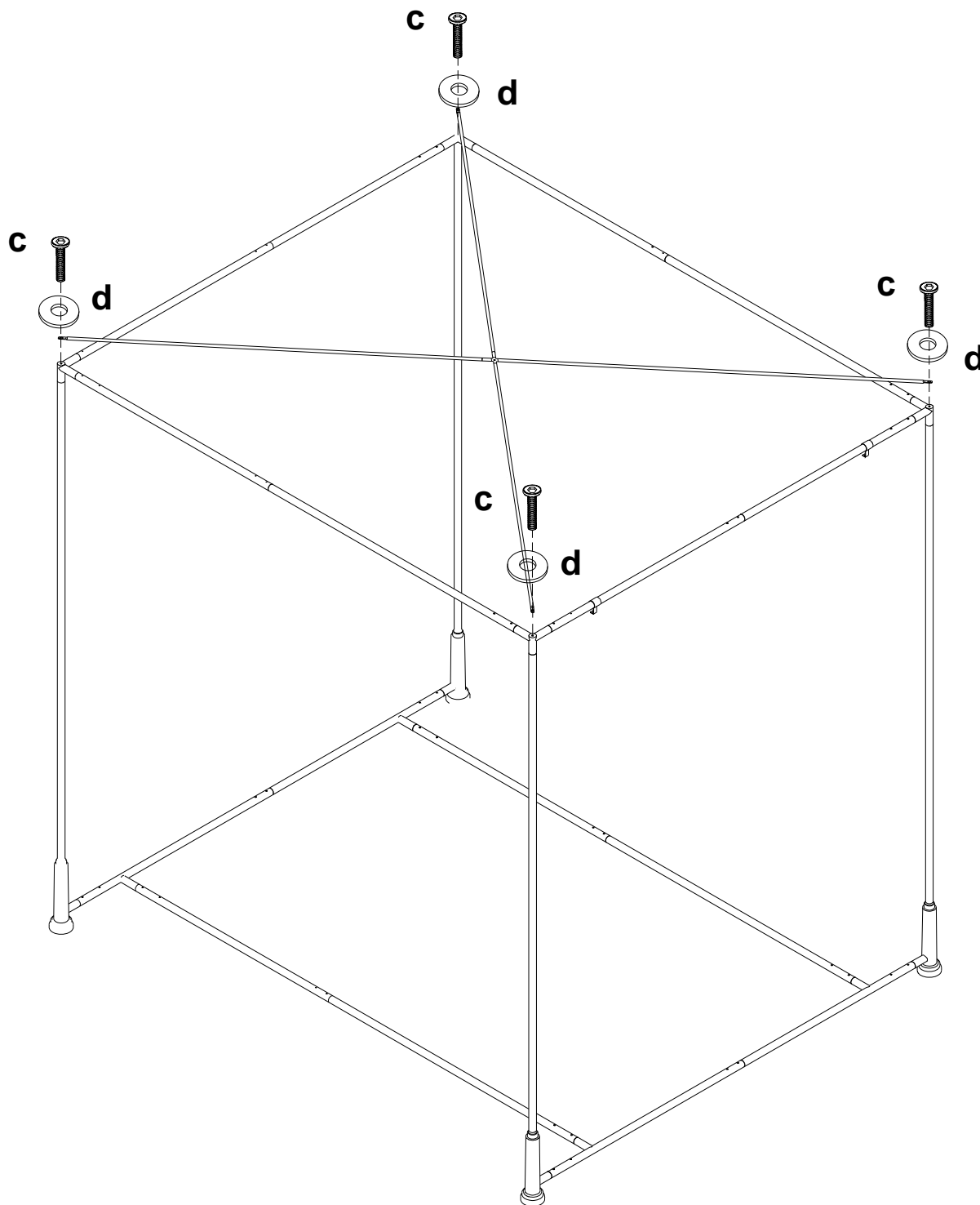

Mount The Canopy To The Wall:

NOTE: For safe mounting it is essential to use the proper hardware for your wall type. The hardware included is meant for drywall or wood stud mounting only. If walls are concrete, brick or plaster, please consult your local hardware store for assistance in selecting the appropriate hardware. **Mount to wood studs whenever possible.**

1. Move the Canopy Frame to the desired place beside the wall. And make sure the mounting bracket against the wall.
2. Use a sharp pencil or a screw to mark the wall through the hole located in the Bracket. This mark is the insertion mark for the provided hardware (**Mount to wood studs whenever possible**).

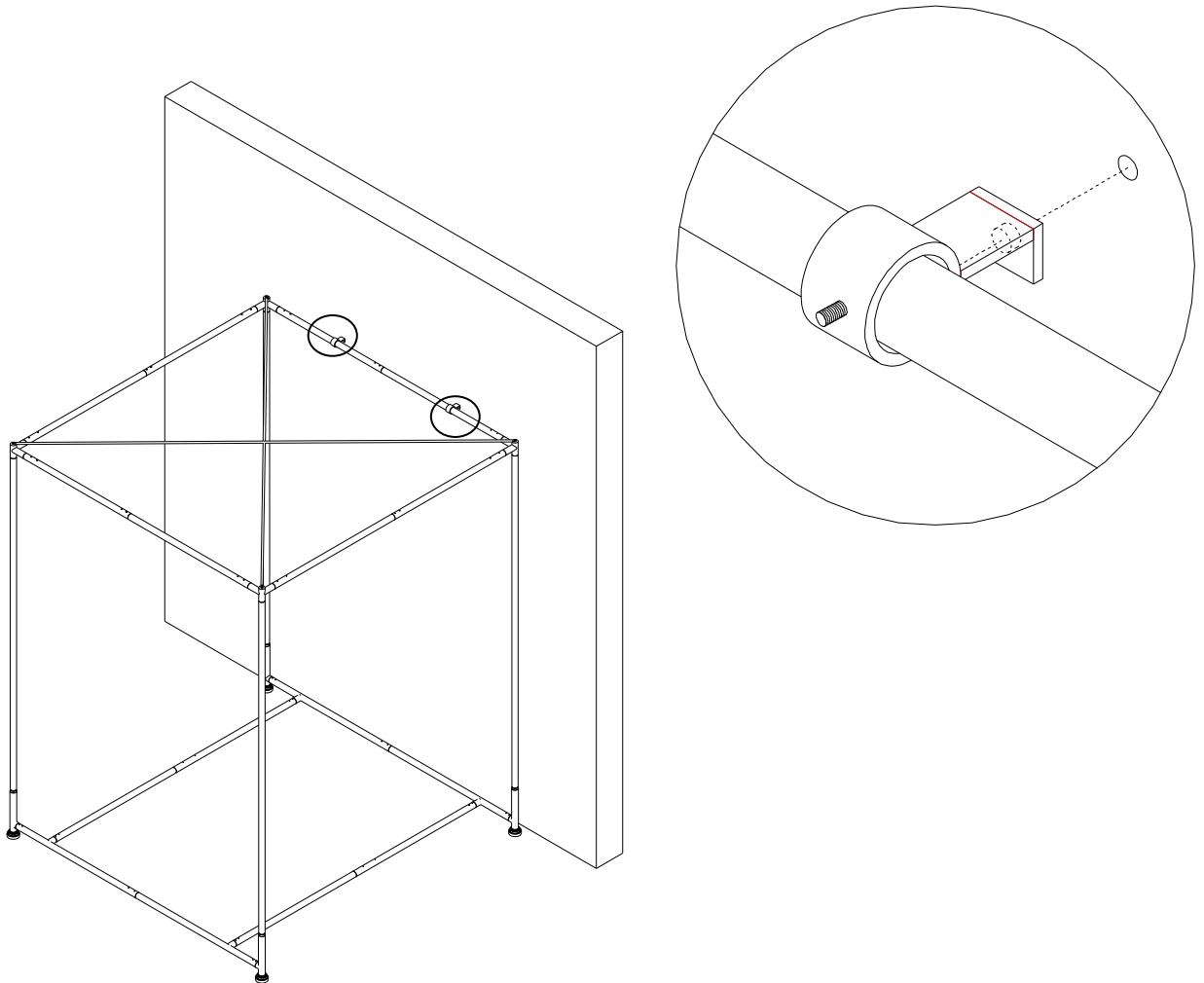

3. The provided Toggle (j) is needed for drywall applications, but cannot penetrate into wall studs (wood). Therefore, we recommend that you use a stud finder to determine if any of the insertion marks align with a wall stud. If so, only a Mounting Screw (i) will be used at that mark. If not, then both a Toggle (j) and a Toggle Screw (k) will be used.

4. **For drywall mounting:** using a screwdriver to engage a Toggle (j) and position the toggle tip against the wall at the insertion mark. Gently push the toggle into the wall as you rotate the toggle clockwise. Continue rotating until the large flange of the toggle is flush with the wall.
5. Once the Toggle (j) is installed into the wall at the marked locations, use a screwdriver to secure the Bracket (I) through toggle Screw (k) into the toggle.

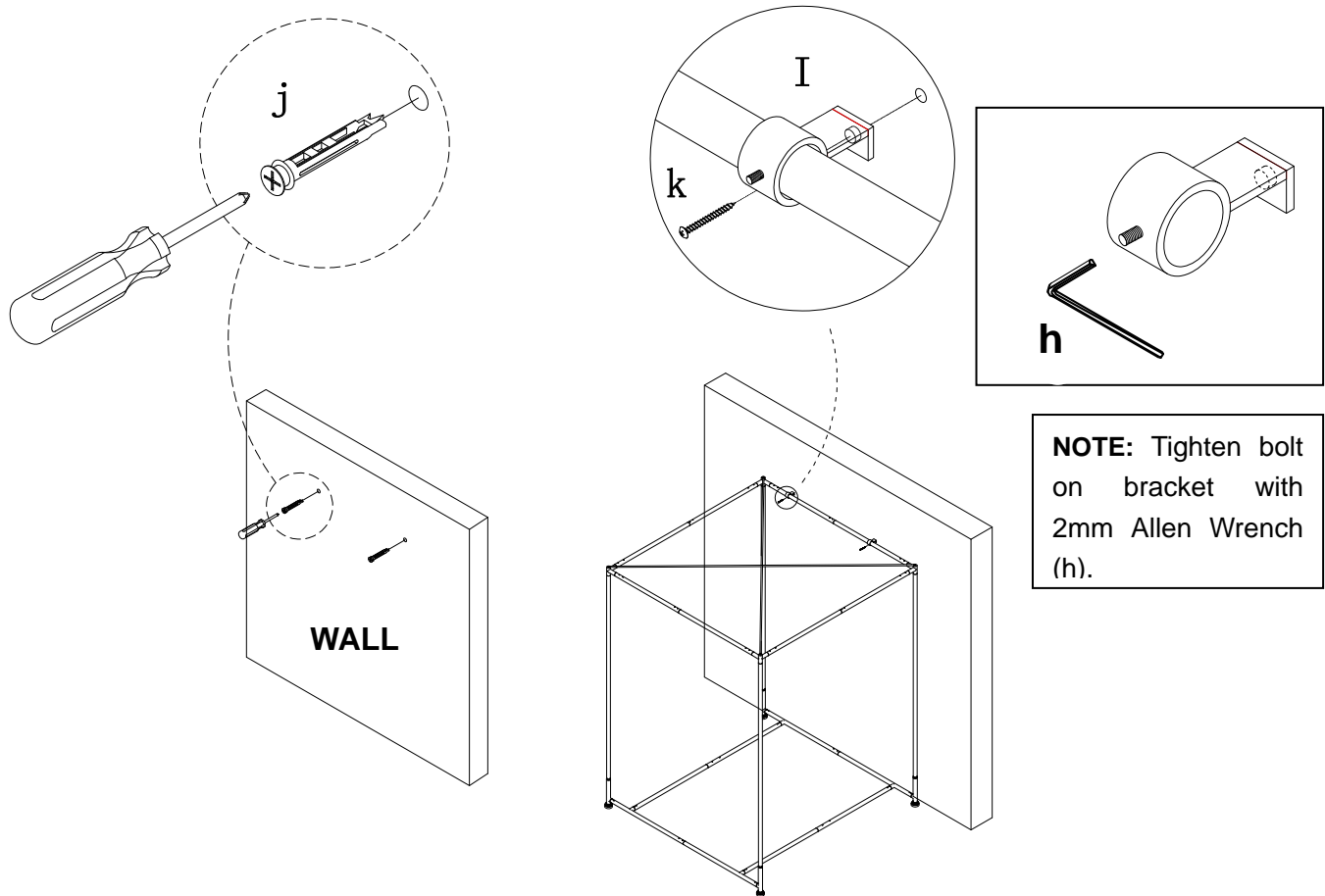

NOTE: Tighten bolt on bracket with 2mm Allen Wrench (h).

6. **For stud mounting:** using a screwdriver to secure the Bracket (I) through Mounting screw (i), simply drive down Mounting Screw (i) for securing.

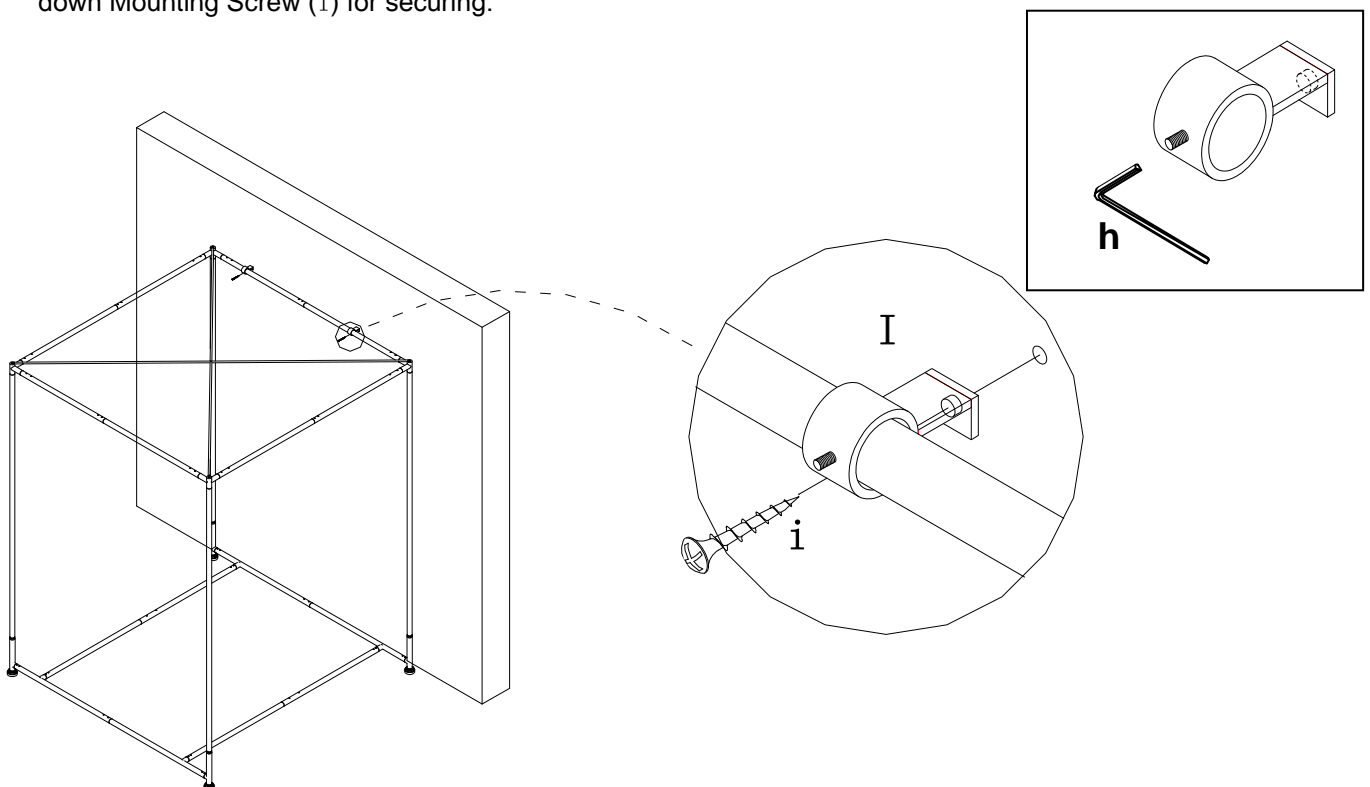

WARNING: Do not allow children to climb on, pull on, or hang from canopy. Failure to follow these instructions can result in serious bodily injury.

7. The assembly is now complete.

Care Instructions:

- Dust often using a clean, soft, dry and lint-free cloth.
- Blot spills immediately and wipe with a clean, damp, cloth.
- We do not recommend the use of chemical cleansers, abrasives or furniture polish on our lacquered finish.
- Hardware may loosen over time. Periodically check to make sure all connections are tight.
Re-tighten if necessary

Thank you for your purchase
Stores | catalog