

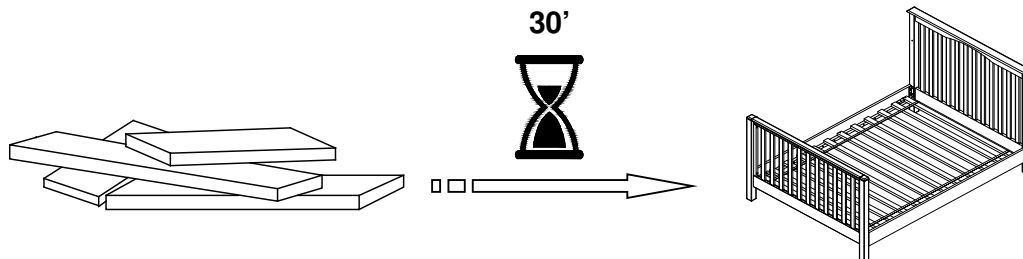

**KENDALL 4:1 FULL BED CONVERSION KIT**  
**KIT DE CONVERSION LIT DE BÉBÉ 4:1 EN LIT 2 PLACES KENDALL**  
**KIT DE CONVERSIÓN A CAMA FULL KENDALL 4:1**



## ! ENGLISH

- Do not dispose of any packaging or contents of the shipping carton until assembly is completed to avoid accidentally discarding small parts or hardware.

## ! FRANÇAIS

- Ne jetez rien des produits d'emballage et du contenu de la boîte jusqu'à ce que l'assemblage soit terminé, afin d'éviter de jeter par mégarde de petites pièces ou des morceaux.

## ! ESPAÑOL

- Para evitar desechar accidentalmente las partes pequeñas o las piezas de ferretería, no tirar el embalaje o contenido de la caja hasta que el ensamblaje esté completo.

---

### Care Instructions:

- Dust often using a clean, soft, dry and lint-free cloth.
- When blot spills, wipe with a clean, damp cloth immediately.
- We do not recommend the use of chemical cleansers, abrasives or furniture polish on our lacquered finish.
- Hardware may loosen over time. Periodically check to make sure all connections are tight. Re-tighten if necessary.

### Instructions d'entretien :

- Épousseter régulièrement avec un chiffon propre, doux et non pelucheux.
- Éponger immédiatement les liquides renversés et essuyer à l'aide d'un chiffon propre et humide.
- L'utilisation de produits nettoyants chimiques, d'abrasifs ou d'encaustiques sur nos finitions laquées n'est pas recommandée.
- Le matériel de fixation peut se desserrer avec le temps. Vérifiez régulièrement afin de vous assurer que tous les raccords sont bien serrés. Resserrez-les au besoin.

### Instrucciones de cuidado:

- Limpiar el polvo con un trapo limpio, suave, seco y libre de pelusas.
- Secar los derrames de inmediato y limpiar con un trapo limpio y húmedo.
- Recomendamos no usar limpiadores químicos, abrasivos o lustramuebles sobre el acabado barnizado.
- Las piezas de ferretería pueden aflojarse con el tiempo. Controlar periódicamente que estén bien ajustadas. Si es necesario, volver a ajustarlas.

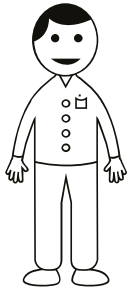

**X2**

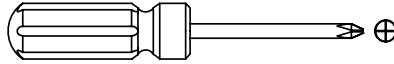

(NOT INCLUDED / NON INCLUS / NO INCLUIDAS)

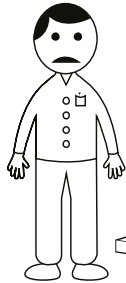
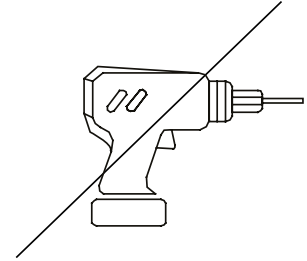

?

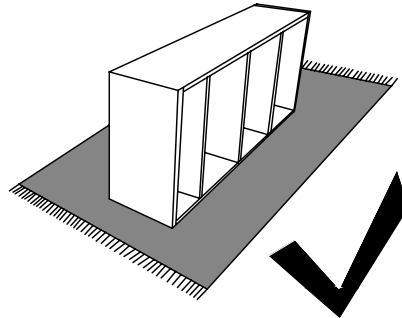
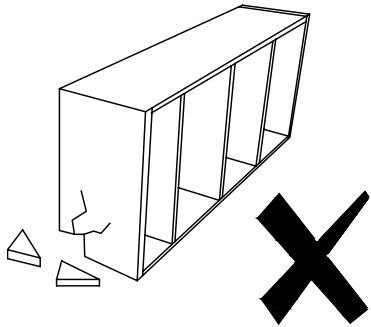
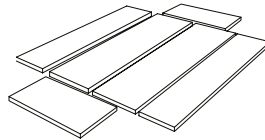
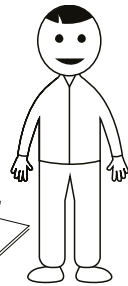
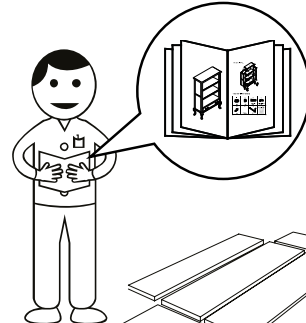
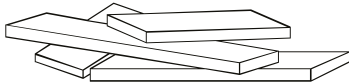
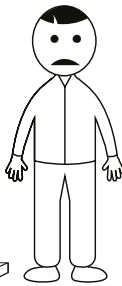

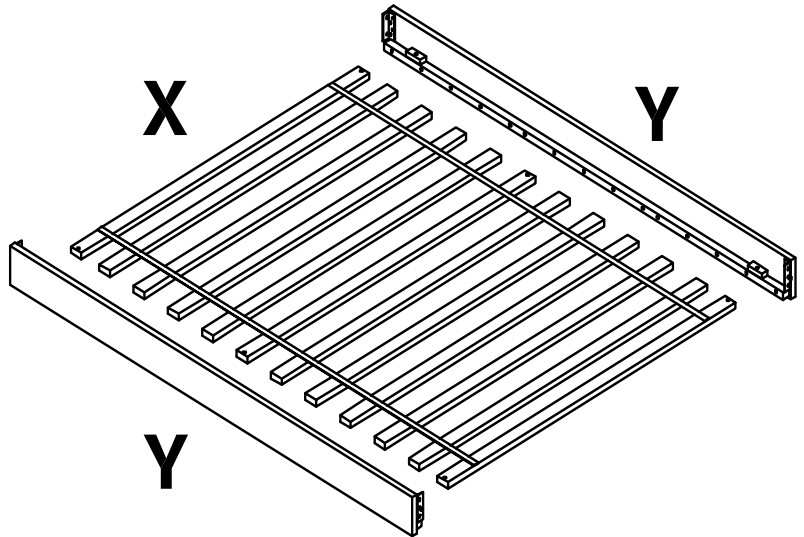
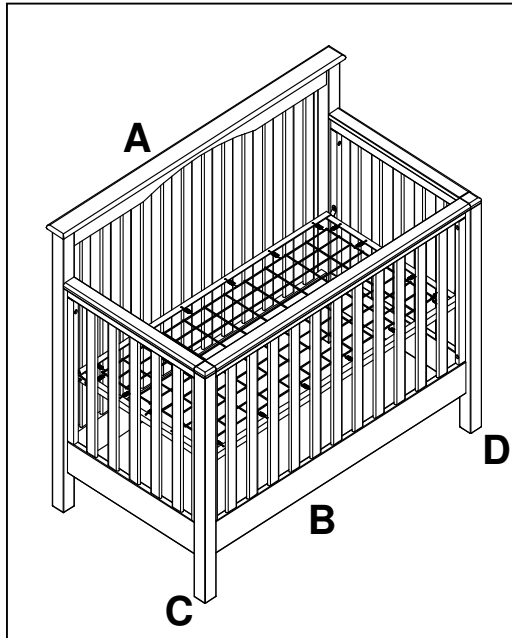

Kendall 4-in-1 Crib (sold separately)  
 LIT D'ENFANT Kendall 4 dans 1 (Vendu séparément)  
 La cuna 4 en 1 Kendall (se vende por separado)

**HARDWARE INCLUDED/ INCLUS/ INCLUIDAS:**

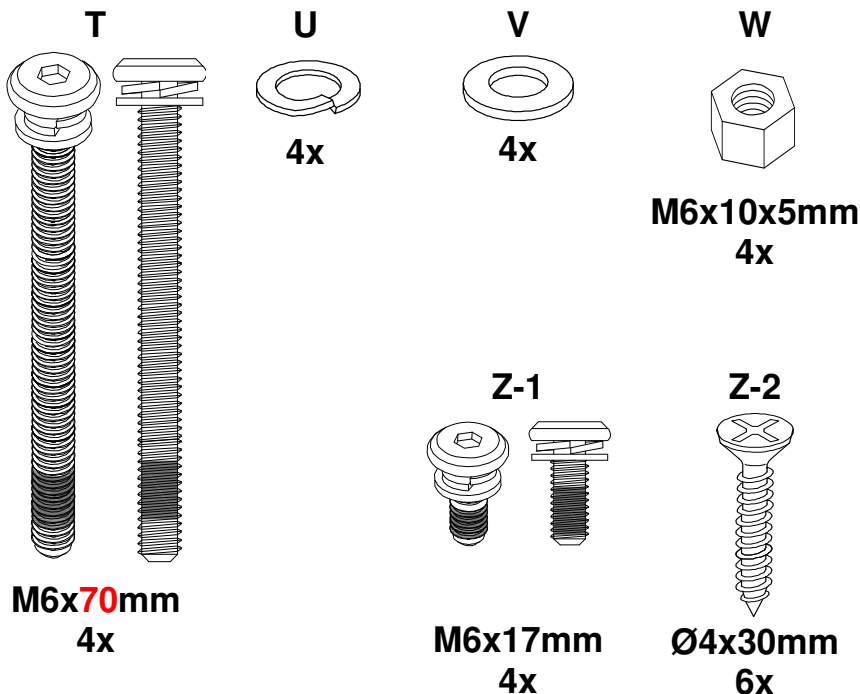

**FROM CRIB / DU LIT / DE LA CUNA:**

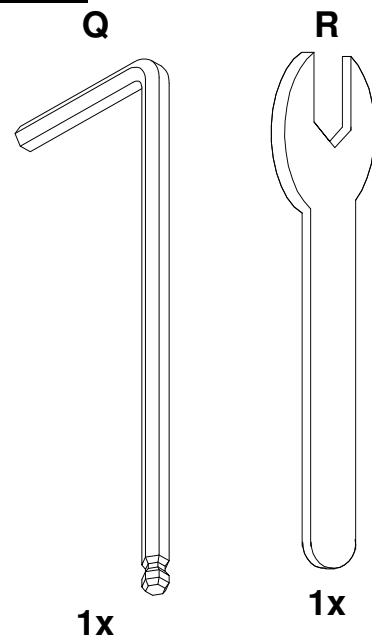

# pottery barn kids

Assembly instructions  
Instructions d'assemblage  
Instrucciones de Ensamblaje

2018.09.25

www.potterybarnkids.com

5/5

## 1

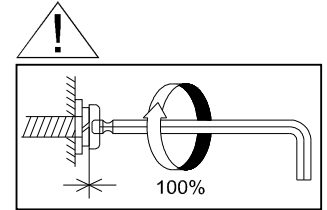
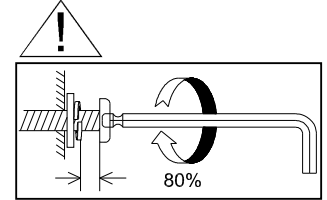
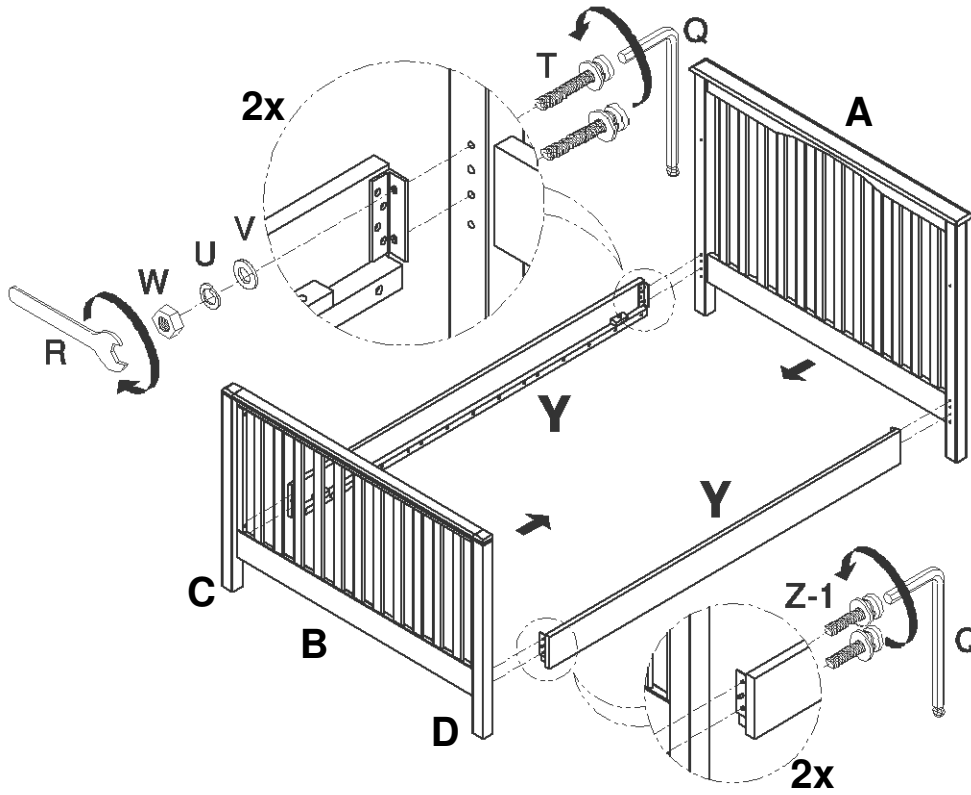

## 2

