

⚠ WARNING	
	<p>Children have died from furniture tipover. To reduce the risk of furniture tipover:</p> <ul style="list-style-type: none">– ALWAYS install anti-tip device provided.– NEVER put a TV on this product.– NEVER allow children to stand, climb or hang on any drawers, doors, or shelves.– NEVER open more than one drawer at a time.– Place heaviest items in the lowest drawers. <p><i>This is a permanent label. Do not remove!</i></p> <p>04-000129-07</p>
	

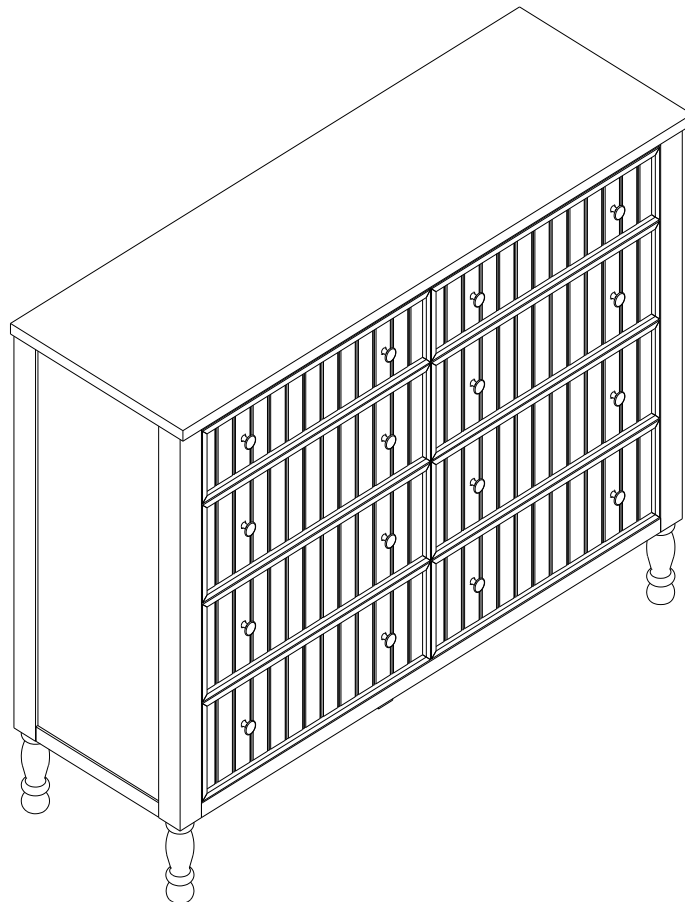

CATALINA

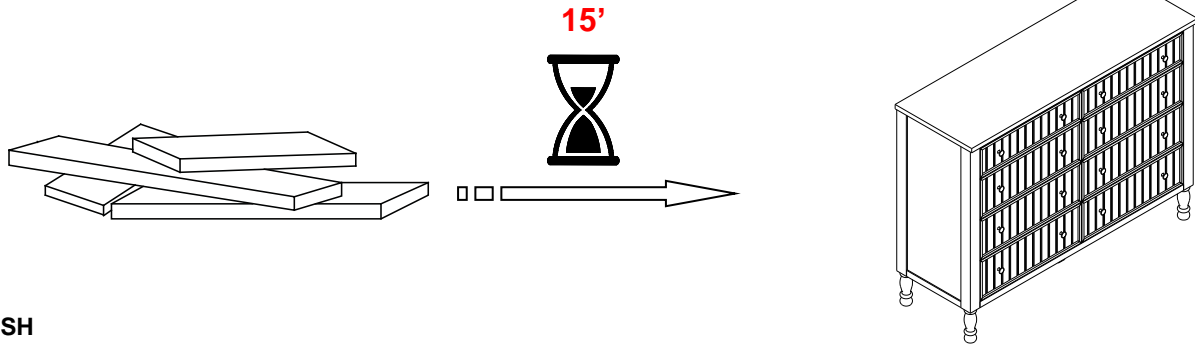

! ENGLISH

- Do not dispose of any packaging or contents of the shipping carton until assembly is completed to avoid accidentally discarding small parts or hardware.

! FRANÇAIS

- Ne jetez rien des produits d'emballage et du contenu de la boîte jusqu'à ce que l'assemblage soit terminé, afin d'éviter de jeter par mégarde de petites pièces ou des morceaux.

! ESPAÑOL

- Para evitar desechar accidentalmente las partes pequeñas o las piezas de ferretería, no tirar el embalaje o contenido de la caja hasta que el ensamblaje esté completo.

Care Instructions:

- Dust often using a clean, soft, dry and lint-free cloth.
- When blot spills, wipe with a clean, damp cloth immediately.
- We do not recommend the use of chemical cleansers, abrasives or furniture polish on our lacquered finish.
- Hardware may loosen over time. Periodically check to make sure all connections are tight. Re-tighten if necessary.

Instructions d'entretien :

- Épousseter régulièrement avec un chiffon propre, doux et non pelucheux.
- Éponger immédiatement les liquides renversés et essuyer à l'aide d'un chiffon propre et humide.
- L'utilisation de produits nettoyants chimiques, d'abrasifs ou d'encaustiques sur nos finitions laquées n'est pas recommandée.
- Le matériel de fixation peut se desserrer avec le temps. Vérifiez régulièrement afin de vous assurer que tous les raccords sont bien serrés. Resserrez-les au besoin.

Instrucciones de cuidado:

- Limpiar el polvo con un trapo limpio, suave, seco y libre de pelusas.
- Secar los derrames de inmediato y limpiar con un trapo limpio y húmedo.
- Recomendamos no usar limpiadores químicos, abrasivos o lustramuebles sobre el acabado barnizado.
- Las piezas de ferretería pueden aflojarse con el tiempo. Controlar periódicamente que estén bien ajustadas. Si es necesario, volver a ajustarlas.

Williams-Sonoma Inc.

Assembly Instructions
Instructions d'assemblage
Instrucciones de Ensamblaje

Pottery Barn -Pottery Barn Teen – Pottery Barn Kids – Williams Sonoma Home-West elm -Rejuvenation – Mark and Graham – GreenRow

22-Jul-2023

3/6

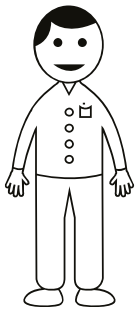

X2

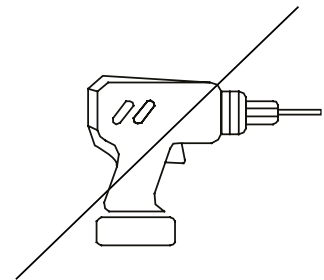
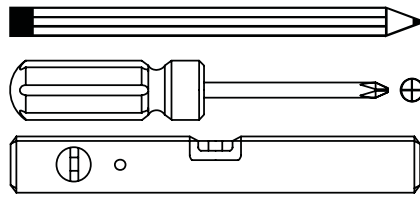

(NOT INCLUDED / NON INCLUS / NO INCLUIDAS)

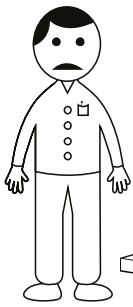

?

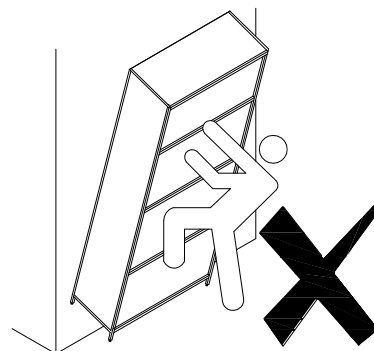
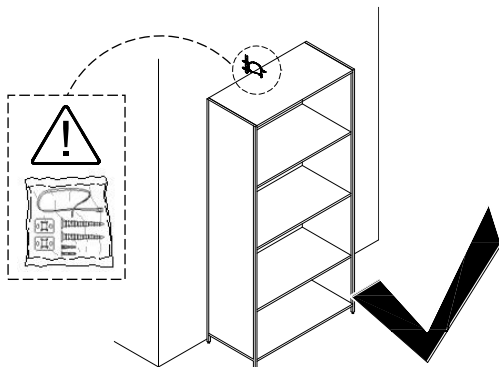
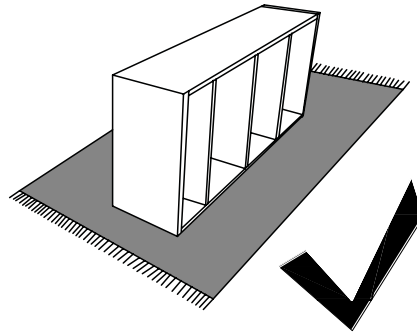
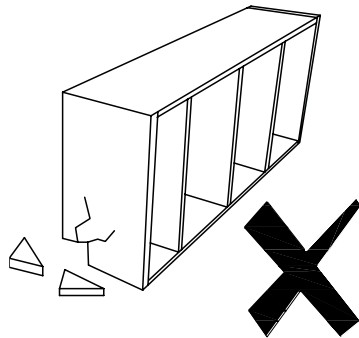
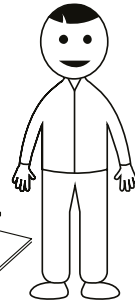
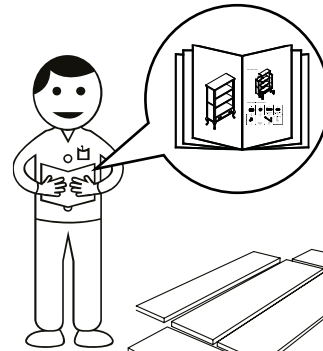
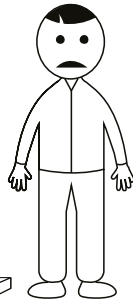

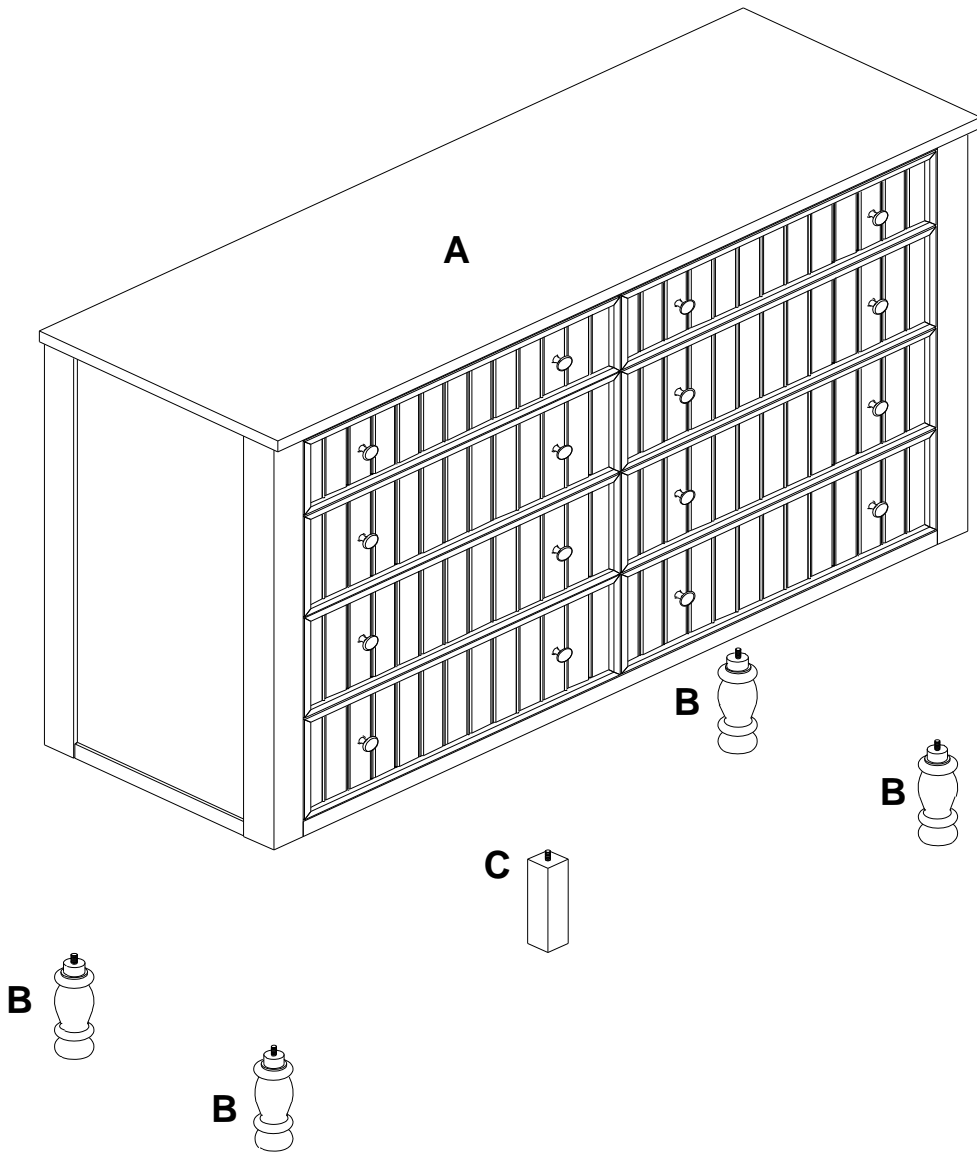

D

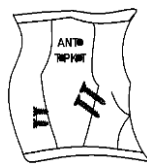

- Anti-tip kit /
- Dispositif anti-basculement/
- Kit anti-volcada

1x

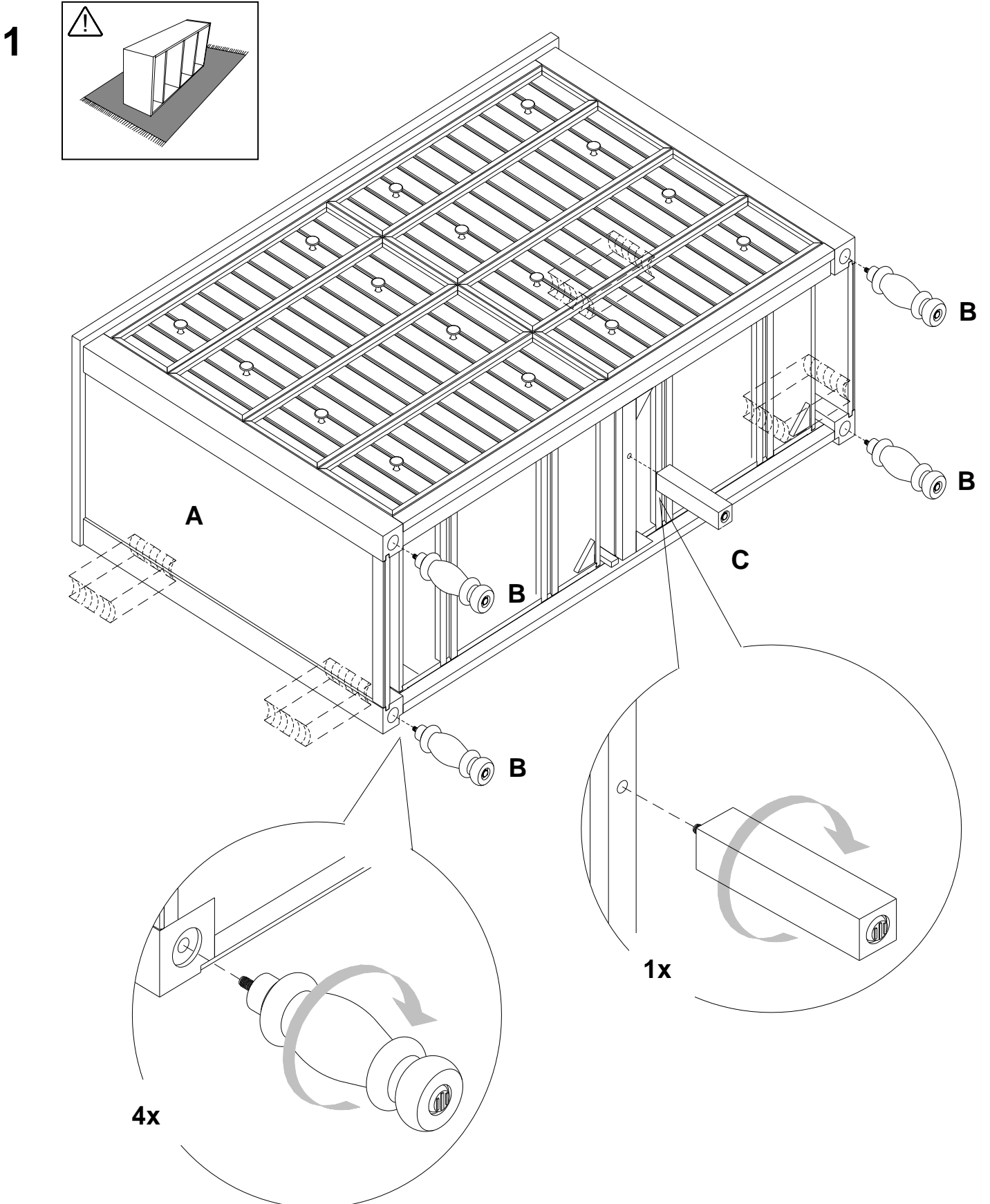

2

