



|  <b>WARNING</b> |   |
|--|---|
|                 | <p><b>Children have died from furniture tipover. To reduce the risk of furniture tipover:</b></p> <ul style="list-style-type: none"><li>• ALWAYS install tipover restraint provided.</li><li>• NEVER put a TV on this product.</li><li>• NEVER allow children to stand, climb or hang on drawers, doors, or shelves.</li><li>• NEVER open more than one drawer at a time.</li><li>• Place heaviest items in the lowest drawers.</li></ul> <p><i>This is a permanent label.<br/>Do not remove!</i></p> <p>04-000129-06</p> |
|                 |   |



## CATALINA

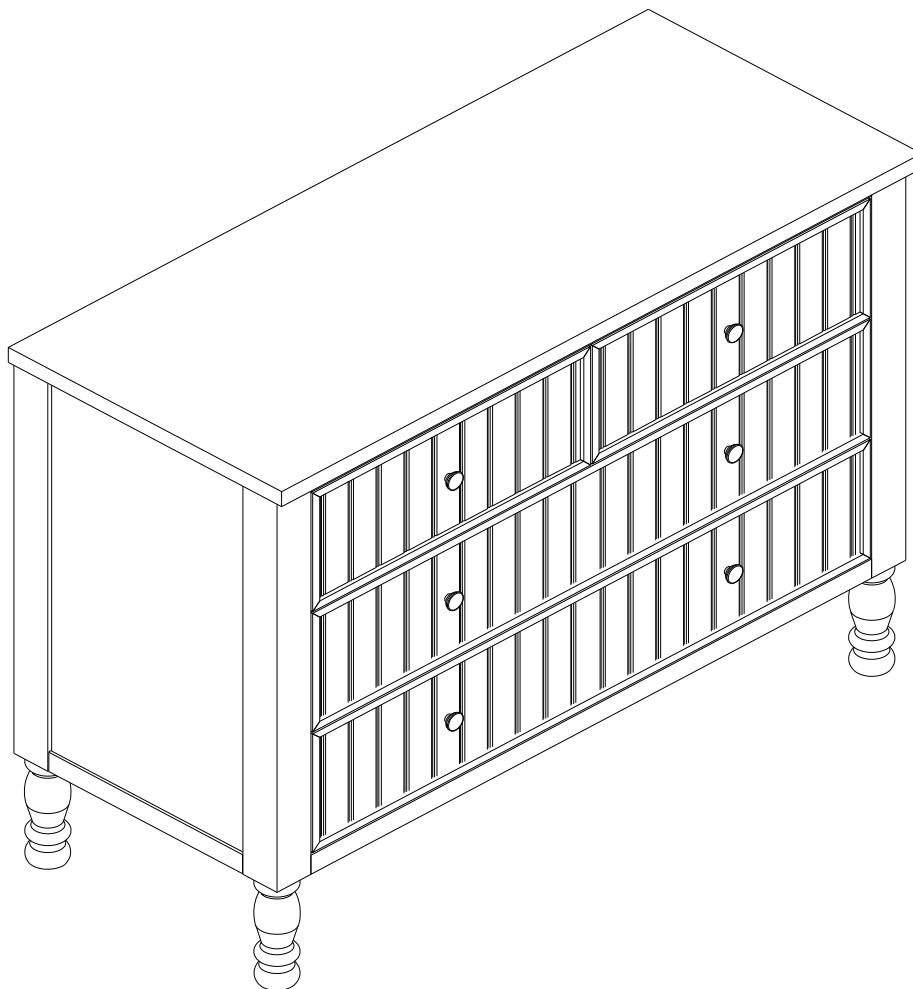
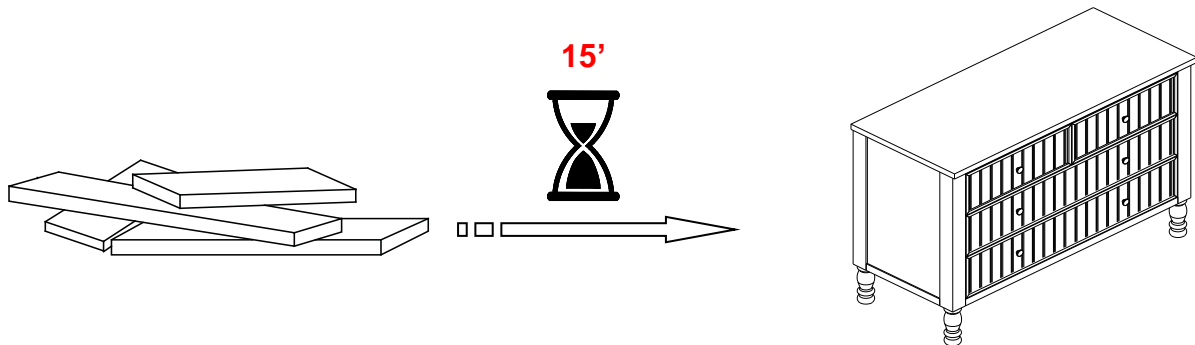

## ! ENGLISH

- Do not dispose of any packaging or contents of the shipping carton until assembly is completed to avoid accidentally discarding small parts or hardware.

## ! FRANÇAIS

- Ne jetez rien des produits d'emballage et du contenu de la boîte jusqu'à ce que l'assemblage soit terminé, afin d'éviter de jeter par mégarde de petites pièces ou des morceaux.

## ! ESPAÑOL

- Para evitar desechar accidentalmente las partes pequeñas o las piezas de ferretería, no tirar el embalaje o contenido de la caja hasta que el ensamblaje esté completo.

### Care Instructions:

- Dust often using a clean, soft, dry and lint-free cloth.
- When blot spills, wipe with a clean, damp cloth immediately.
- We do not recommend the use of chemical cleansers, abrasives or furniture polish on our lacquered finish.
- Hardware may loosen over time. Periodically check to make sure all connections are tight. Re-tighten if necessary.

### Instructions d'entretien :

- Épousseter régulièrement avec un chiffon propre, doux et non pelucheux.
- Éponger immédiatement les liquides renversés et essuyer à l'aide d'un chiffon propre et humide.
- L'utilisation de produits nettoyants chimiques, d'abrasifs ou d'encaustiques sur nos finitions laquées n'est pas recommandée.
- Le matériel de fixation peut se desserrer avec le temps. Vérifiez régulièrement afin de vous assurer que tous les raccords sont bien serrés. Resserrez-les au besoin.

### Instrucciones de cuidado:

- Limpiar el polvo con un trapo limpio, suave, seco y libre de pelusas.
- Secar los derrames de inmediato y limpiar con un trapo limpio y húmedo.
- Recomendamos no usar limpiadores químicos, abrasivos o lustramuebles sobre el acabado barnizado.
- Las piezas de ferretería pueden aflojarse con el tiempo. Controlar periódicamente que estén bien ajustadas. Si es necesario, volver a ajustarlas.

# Williams-Sonoma Inc.

Assembly Instructions  
Instructions d'assemblage  
Instrucciones de Ensamblaje

Pottery Barn -Pottery Barn Teen – Pottery Barn Kids – Williams Sonoma Home-West elm -Rejuvenation – Mark and Graham - GreenRow

09-May-2023

3/7

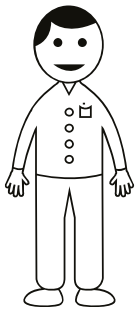

**X2**

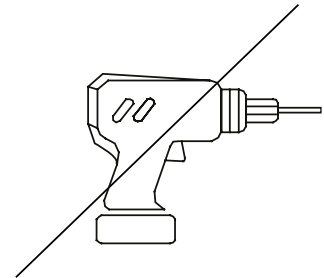
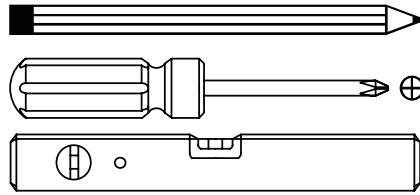

(NOT INCLUDED / NON INCLUS / NO INCLUIDAS)

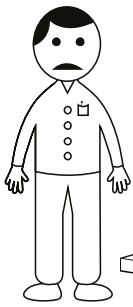

?

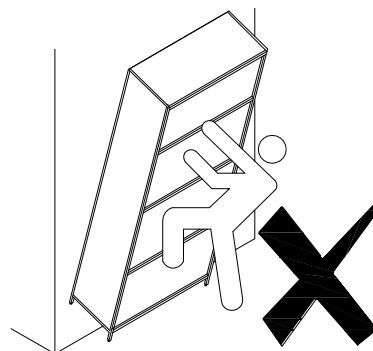
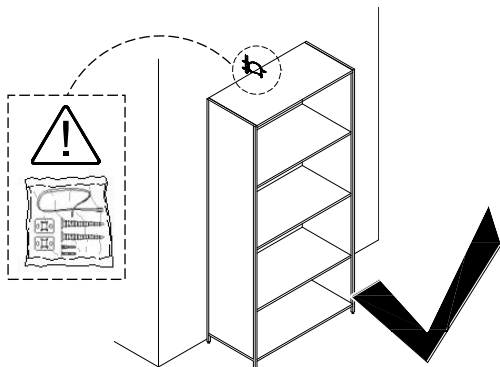
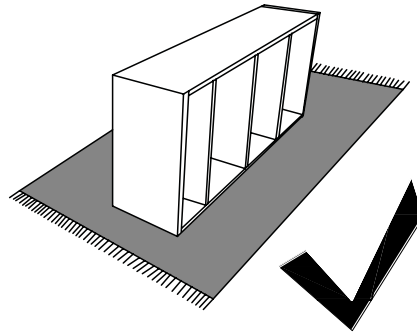
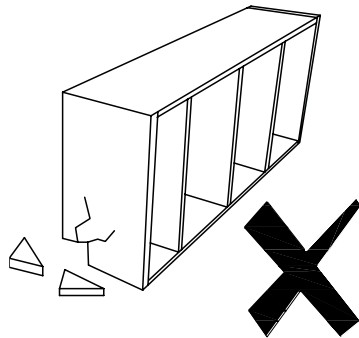
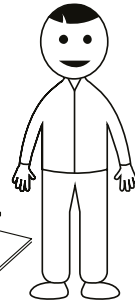
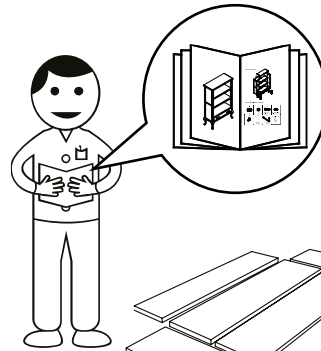
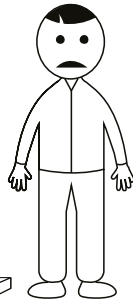

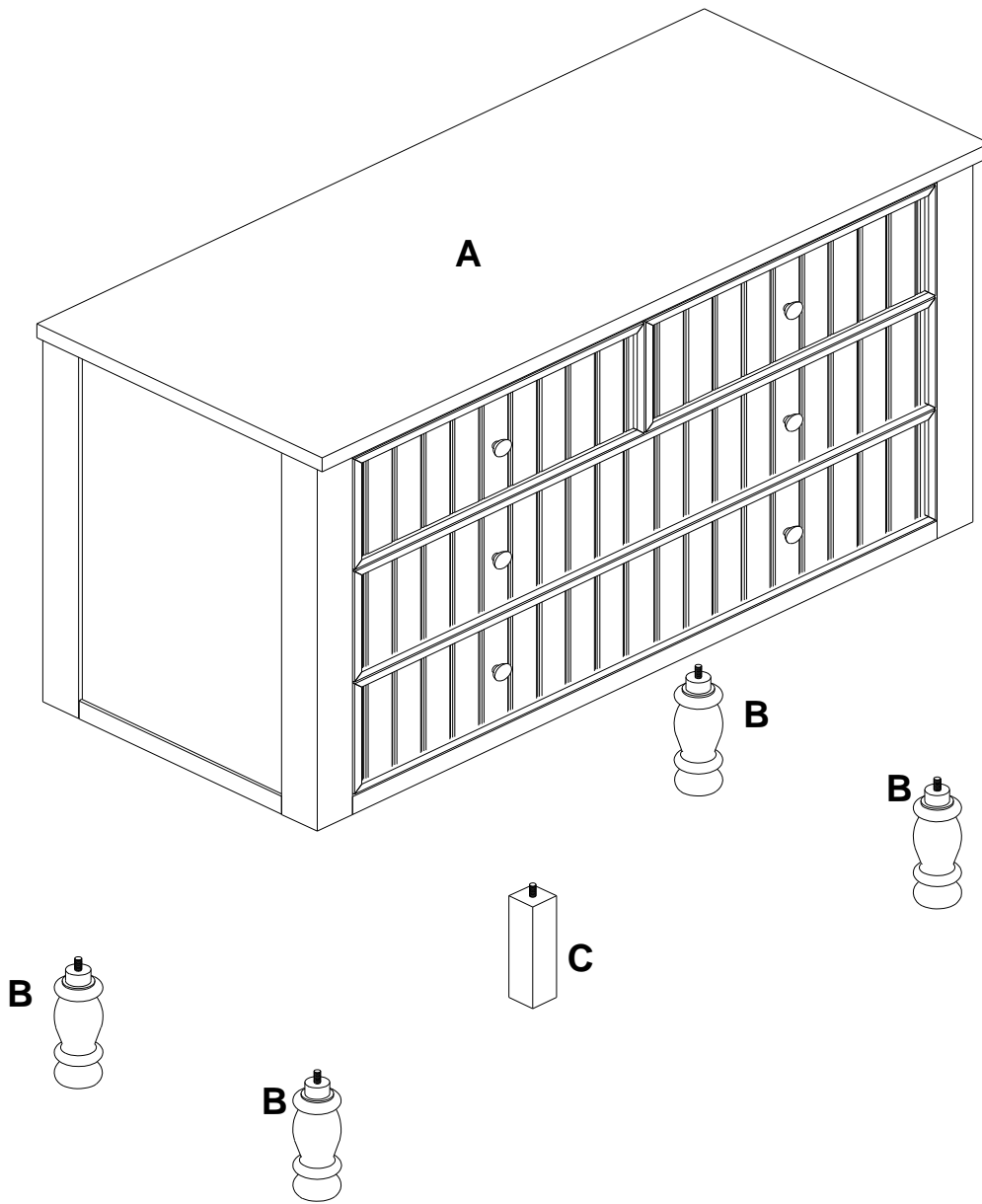

D



- Anti-tip kit /
- Dispositif anti-basculement/
- Kit anti-volcada

1x

E

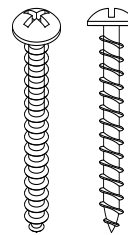

#8x20mm

2x

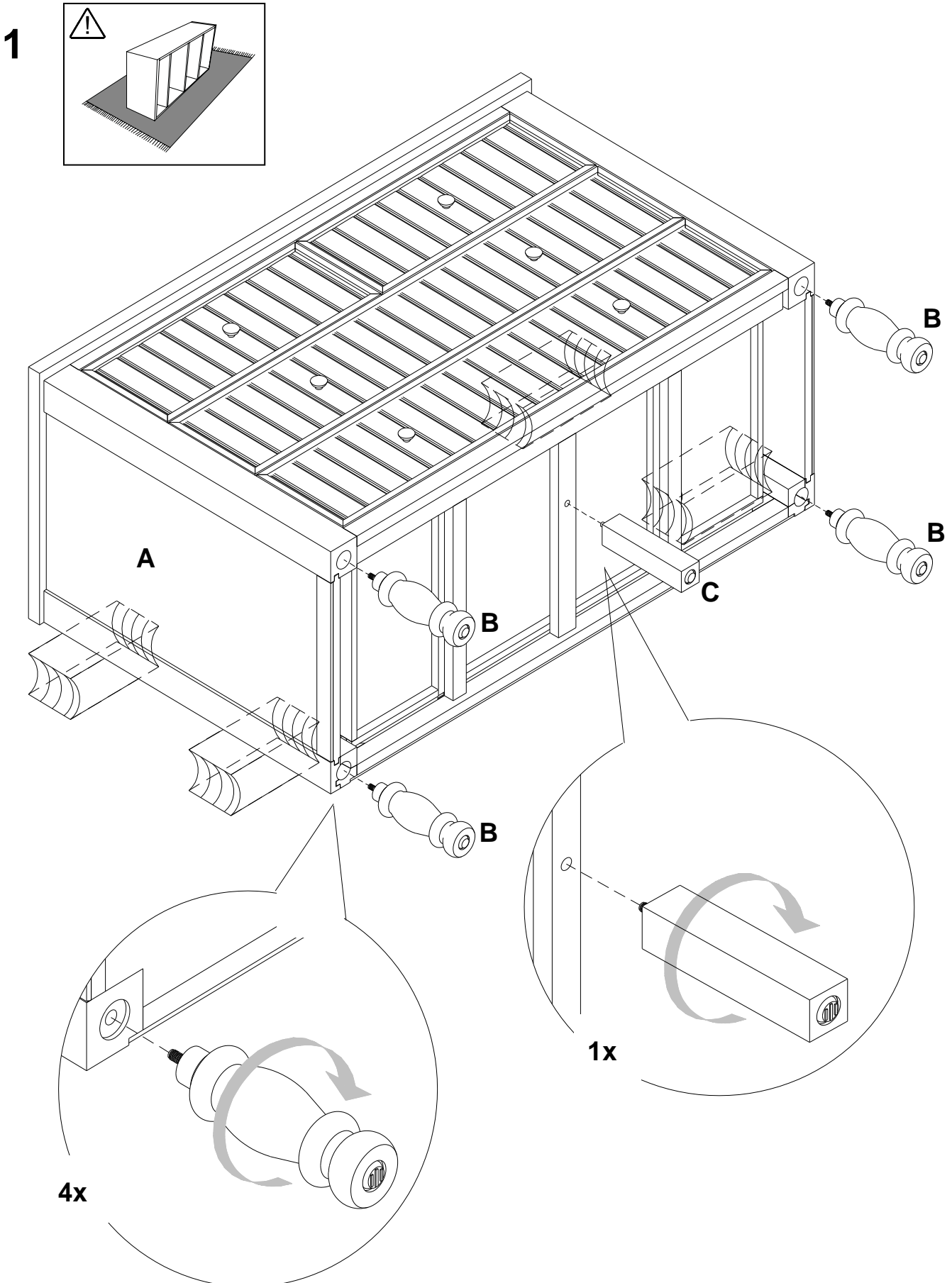

## 2

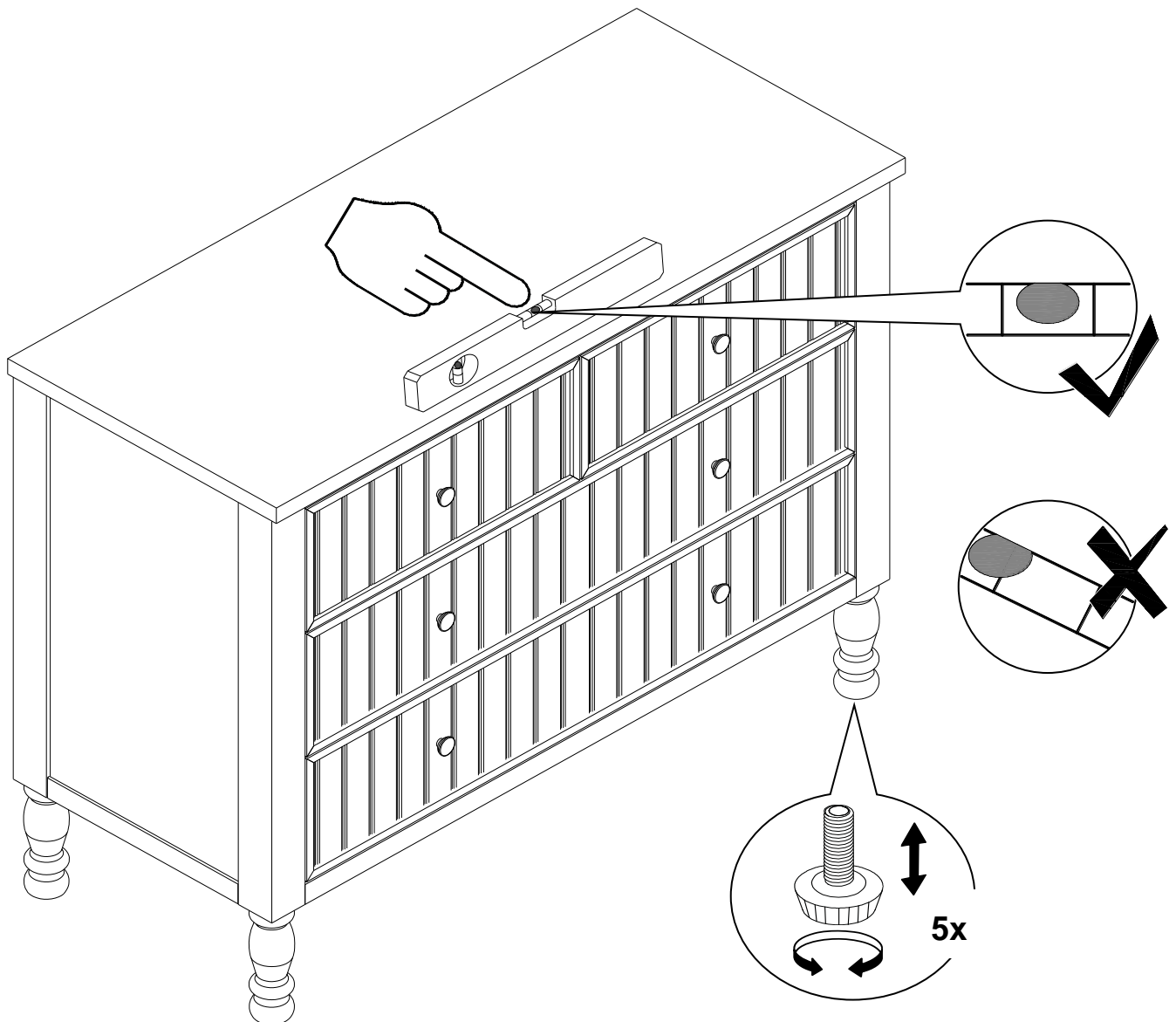

## 3

